

## Int/External Flexi termination box - Installation

### Description

The Flexibox is for Fibre to the Premises [FTTP] applications. The box houses splice and storage for excess/loop through fibre elements.

This version of the box can accept up to 48 cables using grommets or 24 cables via gland entry ports using bottom faces of the box, with space for up to 96 fibre splices, loop through capabilities and a patch panel for pre-connectorized drop cables.

### Tools & Additional Items Required

**Tools:**

Cable /tube stripping tools, adjustable spanner (optional), electric drill, M5 drill bit, pozi screwdriver, fibre splicing equipment, hammer.

**Additional items**

Splice protectors (12 x2.2mm)

**Part Number**

XKTSC00050

Single way gland – 5 to 9mm

XKTSC02335

Single way gland – 6 to 12mm

XKTSC02471

Dual way gland – 4 to 6mm

XKTSC02542

3-way gland – 2.5 to 4.5mm

XKTSC02774

## CONTENTS

1. Box Opening
  - How to open the box for installation
2. Box Installation
  - How to mount the box to a wall
  - How to mount the box to a pole
3. Input/output Cable Installation
  - How to install a cable/gland into the box
  - How to route the fibres around the box
  - Adding a cable to a pre-existing cable gland
4. Fibre routing
  - How to route fibres around the box for splicing
  - How to store excess fibre lengths around the box
5. Box closedown and secure
  - How to close and secure the box

## 1.0 BOX OPENING

### Step 1



- If installing an external Flexibox (this will be black in colour) then using a flathead screwdriver, pivot the 4 toggles into the open position.
- For an internal Flexibox, skip to step 2.

## 1.0 BOX OPENING

### Step 2

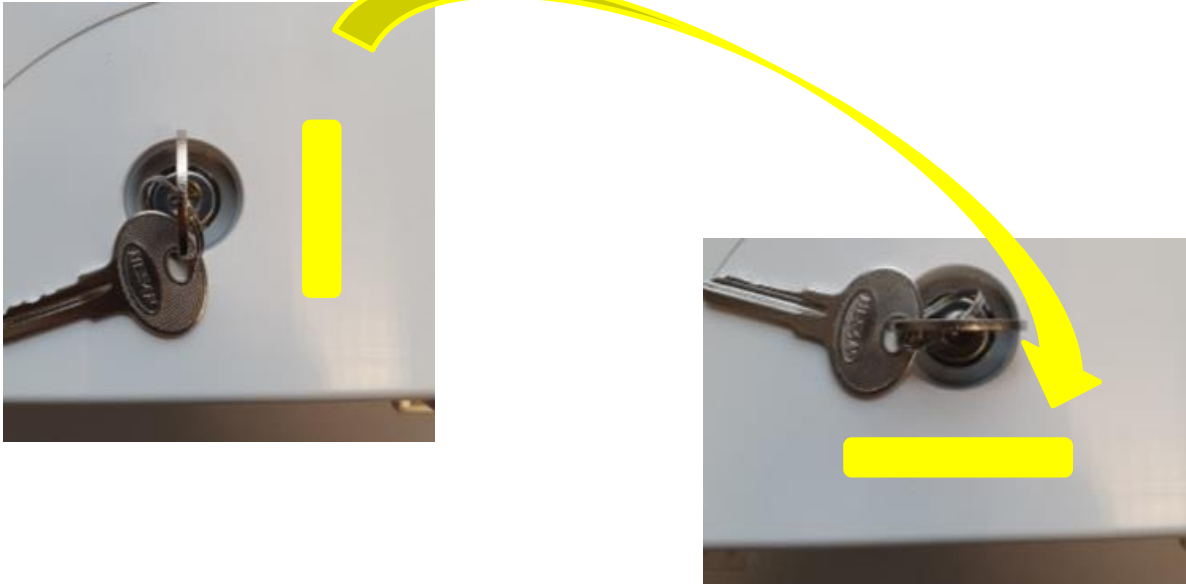

- If using a lock, use the key provided, insert into lock and turn 90° clockwise so the key is in the horizontal unlock position.
- If not using a lock, skip to step 3.

## 1.0 BOX OPENING

### Step 3

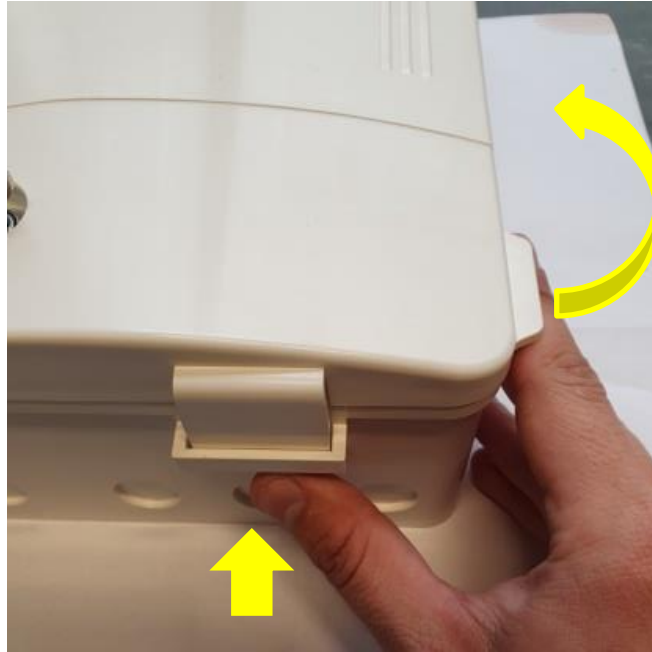

With the key [and toggles] remaining in the **unlock** position:

- Simultaneously push the two clips on the bottom face and lift to open the cover using the small tabs on either side.

## 1.0 BOX OPENING

### Step 4

To remove cover, follow step 5, to retain cover in open position, follow step 6.

## 1.0 BOX OPENING

### Step 5

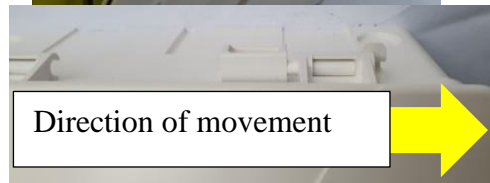

- With the cover open at around 90°, push the tab on the top face as indicated and slide the cover right horizontally to remove.
- Set cover aside until box needs to be closed and secured.

## 1.0 BOX OPENING

### Step 6



- If you are unable to remove cover and set aside, for example in aerial installations, push the cover to just over 180° where the cover will support itself.
- You will hear an audible click when the cover snaps over the bump on the base.

## 2.0 BOX WALL/POLE MOUNTING

### Step 1

**For wall mounting using INTERNAL mounting positions, follow section 1 to open box and remove cover, then follow steps 2 and 3.**

**For wall mounting using EXTERNAL mounting positions, follow steps 4 and 5.**

**For pole mounting follow step 6.**

**Note: Internal mounting is only suitable for internal environments where moisture ingress is highly unlikely.**



## 2.0 BOX WALL/POLE MOUNTING

### Step 2

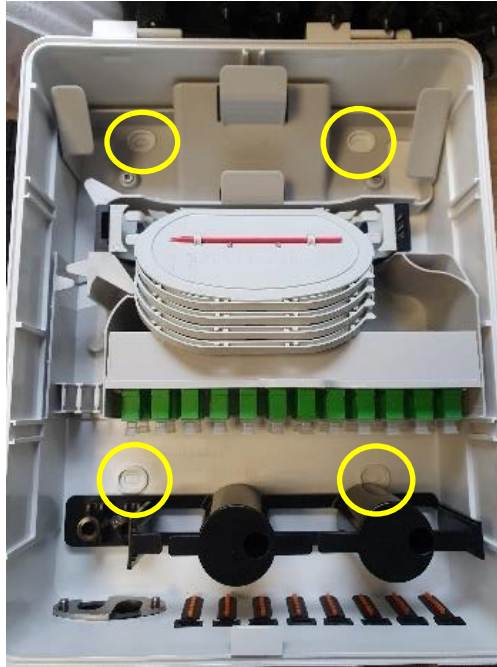

- Using the correct tools and practises, knockout the 4 plastic surfaces on the base as shown.
- Place the box in the desired position on the wall and mark all 4 knocked out positions with a marker.

**NOTE: mark the centre of the opening.**

## 2.0 BOX WALL/POLE MOUNTING

### Step 3



- Remove box and drill each marked position using an M5 drill bit.
- Fit a wall plug to each drilled hole.
- Place box back into position and use the M5 x 25 wood screws to secure box in all 4 positions.

**NOTE: Ensure box cover hinge is at the top of the box when secured in its final position.**

## 2.0 BOX WALL/POLE MOUNTING

Step 4



- Place the box in the desired position on the wall and mark all 3 external feet positions with a marker.

## 2.0 BOX WALL/POLE MOUNTING

### Step 5



- Remove box and drill each marked position using an M5 drill bit.
- Fit a wall plug to each drilled hole.
- Place box back into position and use the M5 x 25 wood screws to secure box in all 3 positions.

**NOTE: Ensure box cover hinge is at the top of the box when secured in its final position.**

## 2.0 BOX WALL/POLE MOUNTING

### Step 6

### To pole mount using bracket

- If box is supplied already attached to bracket go straight to step 9.
- If bracket is supplied separately as a kit, follow steps 7 to 9.

## 2.0 BOX WALL/POLE MOUNTING

### Step 7



- To assemble wall bracket to box, locate top pin on bracket and top hole on base. Slide base hole over pin and sit in position, ensuring the pin overlaps the base.

## 2.0 BOX WALL/POLE MOUNTING

### Step 8



- Line up the two holes positions on the base with the two feet on the cover and screw supplied screws into position.

## 2.0 BOX WALL/POLE MOUNTING

### Step 9



- With bracket assembled to box, place the two band clamps through the strap holes, lift into position and tighten using flathead screwdriver.



## 3.0 INPUT CABLE INSTALLATION

### Step 1

**Open box and remove cover**

**To access box, follow all steps in section 1 to open and remove cover.**

## 3.0 INPUT CABLE INSTALLATION

### Step 2

- Ensure you have a correct oval port for the cable to be installed, regardless of whether you require a loop.
- Strip 2m of the cable, either midspan or butt to be spliced.

**Note: If installing a second cable into an existing oval port, remove any blank and move to step 5.**

### 3.0 INPUT CABLE INSTALLATION

**Step 3**



- Assemble Oval port around cable as per Installation Guide provided in the kit.
- Push the cable and oval port through the hole in the base until the lip sits flush with the edge as shown.

**Note: Do not fully compress rubber seal until the oval is in its final position. You may need to decompress to push through hole in base.**

### 3.0 INPUT CABLE INSTALLATION

Step 4

Central Strength member

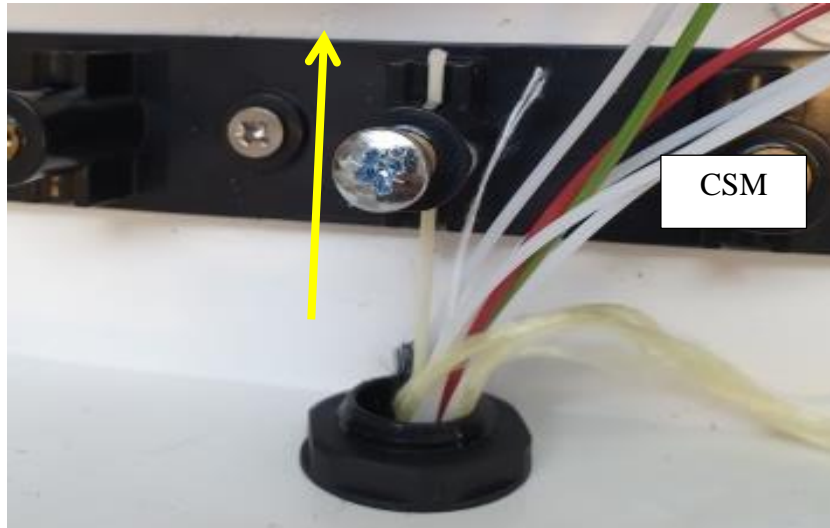

- NOTE: if installing a cable with a CSM, thread this through the hole on the retention bracket at this point and tighten screw to clamp CSM.
- Fully tighten oval port screws once complete.

### 3.0 INPUT CABLE INSTALLATION

Step 5

**Aramid Strength member**

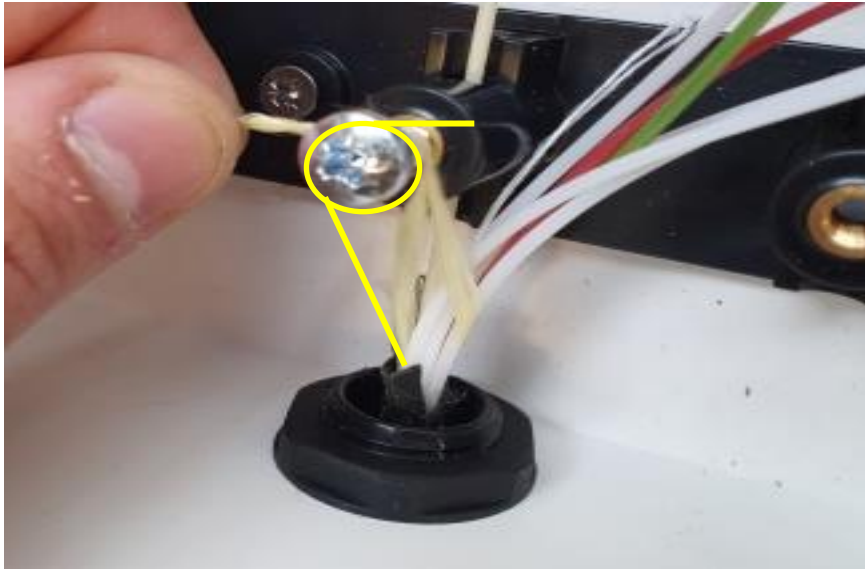

- If the cable contains an aramid strength member, wrap the aramid around the screw thread as many times as possible and tighten screw.
- Fully tighten oval port screws once complete.

## 3.0 ROUTING FIBRES FOR SPLICING

### Step 1

**If installing a loop, follow step 2.**

**If just splicing, skip to step 3.**

## 3.0 ROUTING FIBRES FOR SPLICING

### Step 2



- To install a loop, coil the fibre units around the loop storage area as shown.
- Hold the fibres in position with the Velcro.

## 3.0 ROUTING FIBRES FOR SPLICING

### Step 3

**If splicing direct to pigtails, follow steps 4 to 5.**

**If splicing to a splitter(s) follow steps 5 to 6.**

- Route the fibres to be spliced onto the trays as shown and splice to the required pigtail.

**Note the sequence on the label on the top of the patch panel.**



## 3.0 ROUTING FIBRES FOR SPLICING

### Step 4

**Repeat step 8 until all splices are completed.**

- Replace tray cover once finished splicing.

### 3.0 ROUTING FIBRES FOR SPLICING

**Step 5**

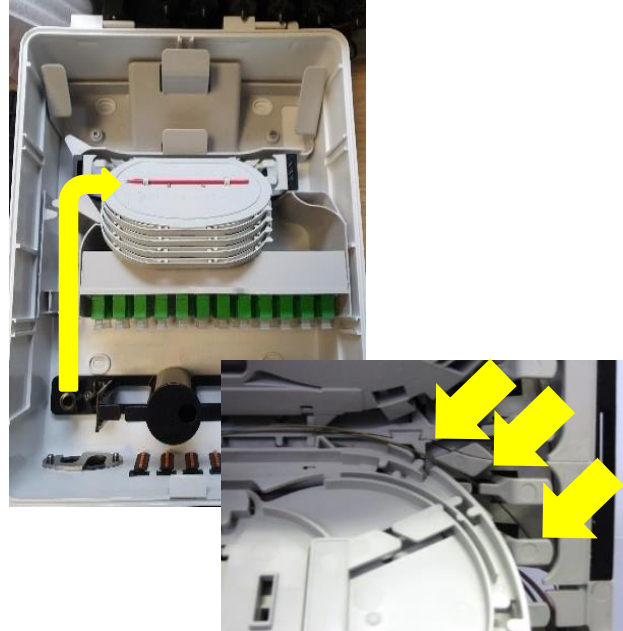

- If splicing to a splitter, locate the tray and required splitter input leg to be spliced.
- Route the input fibres to the required splitter tray ensuring correct routing is used.

### 3.0 ROUTING FIBRES FOR SPLICING

**Step 6**

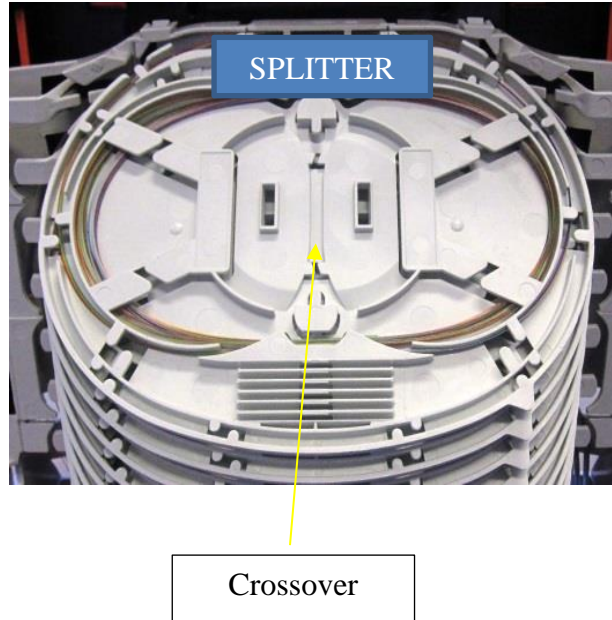

- Splice the input cable to the splitter and route the fibre around the tray, using the crossover point in the centre of the tray if required.
- Replace the tray cover once finished.

## 4.0 INSTALLING A DROP CABLE

### Step 1

**To install a cable using the grommet system, follow steps 2 to 9.**

**To install a cable using the gland system, follow steps 10 to 17.**

## 4.0 INSTALLING A DROP CABLE

### Step 2

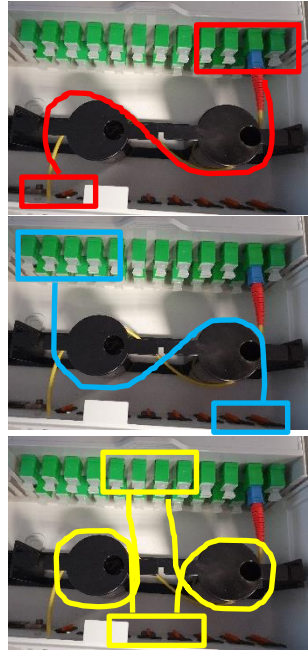

### To install a cable using the grommet system

- Locate the adapter position you need to plug the drop cable connector into.
- Follow the diagram above to determine which input grommet you should use in relation to the adapter position.

**Note: Ensure the drop cable circles at least one mandrel to maintain retention.**

## 4.0 INSTALLING A DROP CABLE

### Step 3

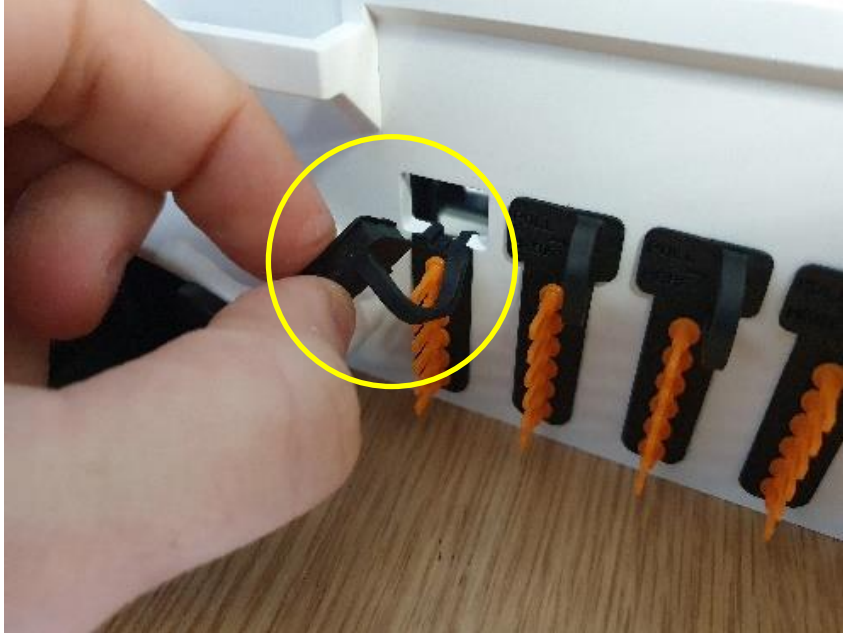

- Pull the tether on the selected grommet to remove just the top section of the seal as shown.

## 4.0 INSTALLING A DROP CABLE

### Step 4



- Feed the connector through the open hole.
- Connect drop cable connector to the desired adapter on the patch panel.

## 4.0 INSTALLING A DROP CABLE

### Step 5

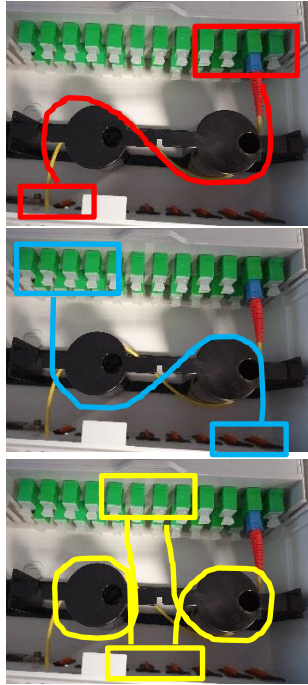

- Once the drop cable is connected to the required adapter, route the cable around as shown also taking any excess into account.

**Note: Ensure each cable is coiled around at least one mandrel to ensure retention.**



## 4.0 INSTALLING A DROP CABLE

### Step 6

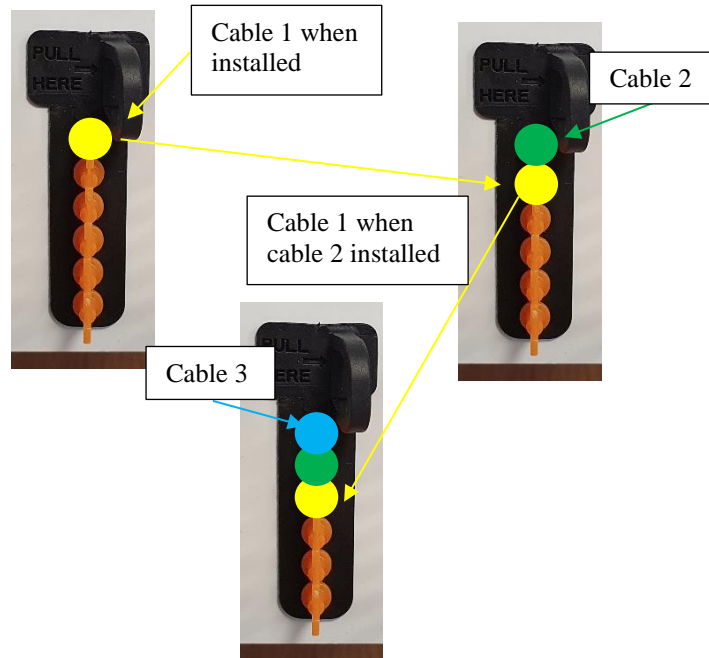

- Drop cables must be laid into the grommet slots from the top down. You must move down any existing cables down to the next position before installing a new cable.
- Ensure not to leave any holes without a cable or blank in them. Blanks should be plugged in individually if accidentally cut.

## 4.0 INSTALLING A DROP CABLE

### Step 7



- Pivot the orange blanks out of the lower half of the seal as shown and sever the join between the blank required where the drop cable will be placed.
- Push remainder of blanks back into position.

## 4.0 INSTALLING A DROP CABLE

Step 8

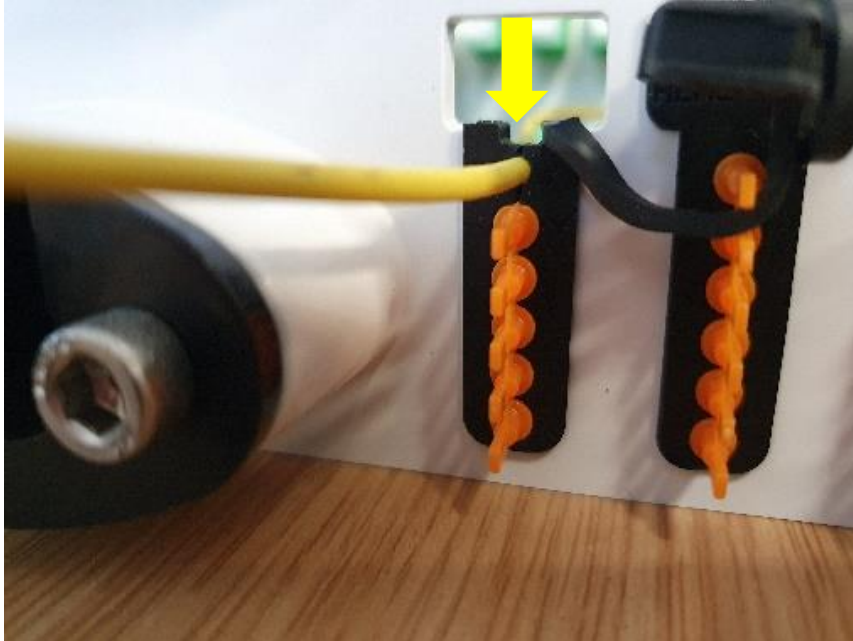

- Lay the cable into its final position by gently pushing down to feed it through the join down the seal.

## 4.0 INSTALLING A DROP CABLE

### Step 9

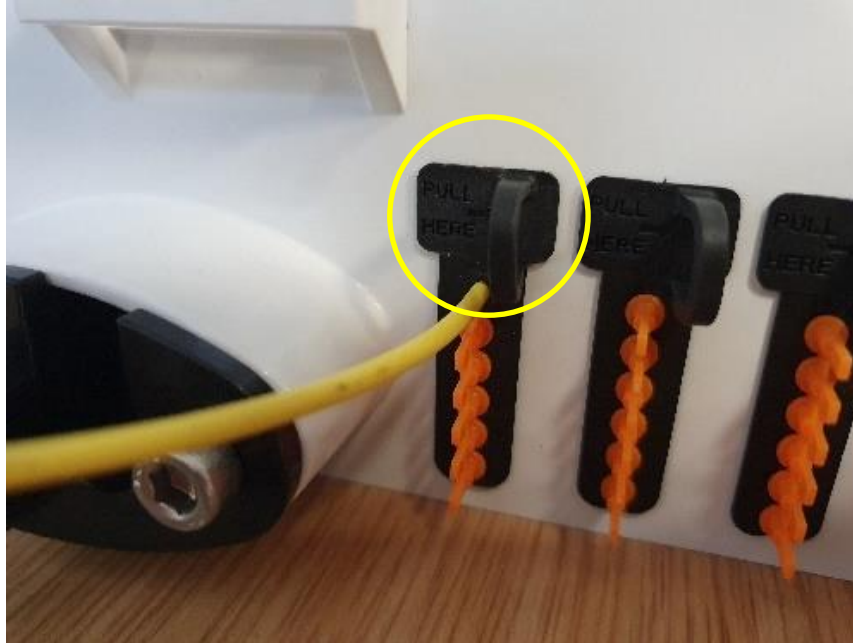

- Push the top of the tethered seal back into position correctly.

**Note: A lip of the seal should be visible inside and outside the box. If not installed correctly this may lead to moisture ingress.**

## 4.0 INSTALLING A DROP CABLE

### Step 10



Single entry gland



Dual entry gland with & without blank

- Select gland as required for the cable being installed:

Single way gland – 5 to 9mm

Single way gland – 6 to 12mm

Dual way gland – 4 to 6mm

3-way gland – 2.5 to 4.5mm

- If installing an additional cable into a pre-existing gland, go to step 4.

## 4.0 INSTALLING A DROP CABLE

### Step 11

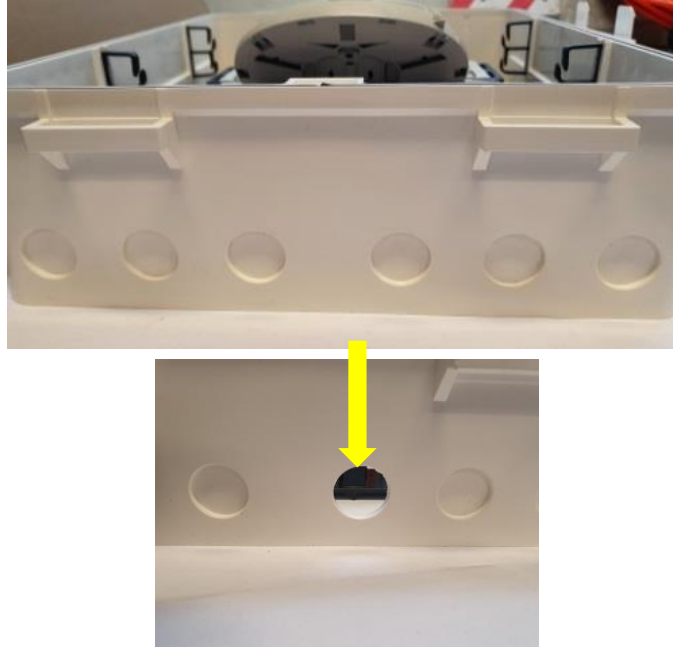

- Locate and select the required entry position to be used for installing the gland.

**NOTE: This can be on top or bottom face of the box.**

- Knockout the plastic from the selected position to allow the gland to be inserted using approved practises and tools.

## 4.0 INSTALLING A DROP CABLE

### Step 12

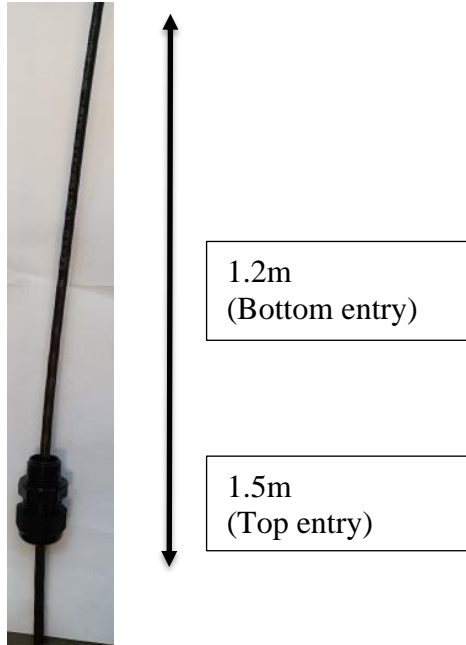

- Remove any existing blanks if necessary and feed 1.2m (1.5m if using a top entry position) of cable through the gland and gland seal as indicated and tighten nut enough to stop cable slipping out.
- Add blank to empty cable position if required.
- Skip step 5 if installing an additional cable into a pre-existing gland.

## 4.0 INSTALLING A DROP CABLE

### Step 13



- Push gland into knocked-out hole position and feed nut over cable on inside of the box. Ensure any rubber seal is securely on the thread of the gland.
- Securely tighten nut on inside of the box.

**NOTE: Use adjustable spanner to fully tighten if necessary.**



## 4.0 INSTALLING A DROP CABLE

### Step 14



- Mark the cable sheath in the position as indicated in the picture above. This is the total cable length to strip.
- Loosen the gland nut on the outside of the box and feed through an additional 15mm of cable.

## 4.0 INSTALLING A DROP CABLE

### Step 15

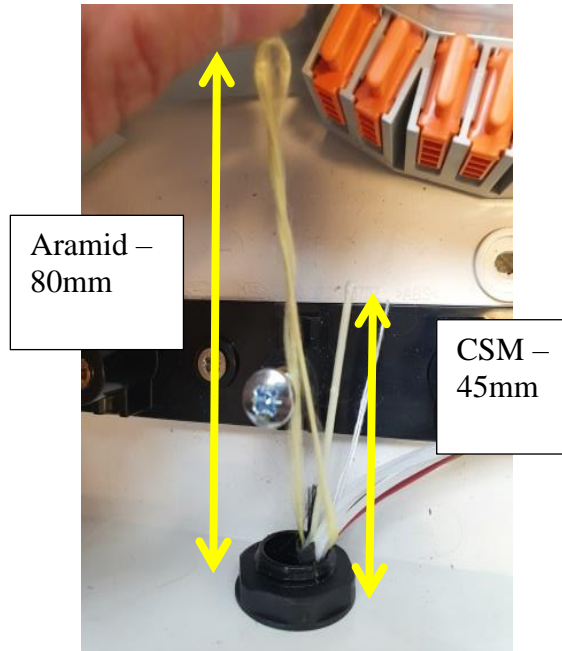

- Strip the cable from open end to where the sheath is marked from step 6 down to fibre elements using approved practises, exposing the strength member as below:

CSM – 45mm

Aramid – 100mm

- Pull cable butt back in line with end of the cable gland once stripped.

**NOTE: if installing a cable with a CSM, thread this through the hole on the retention bracket at this point.**

## 4.0 INSTALLING A DROP CABLE

### Step 16

### Central strength member

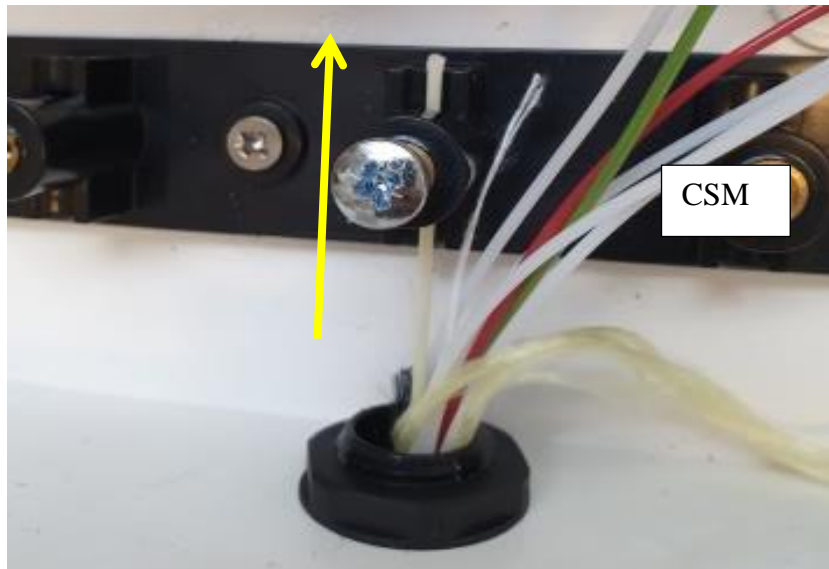

- If the cable contains a CSM, already placed through the hole, tighten screw to clamp CSM.

**NOTE: If installing a second cable into an existing entry, you should follow the same steps as above ensuring the original cable retention is not compromised.**

- Fully tighten the nut on the outside of the gland, ensuring any blanks are used at this point for any empty holes in gland seals.

## 4.0 INSTALLING A DROP CABLE

### Step 17

### Aramid strength member

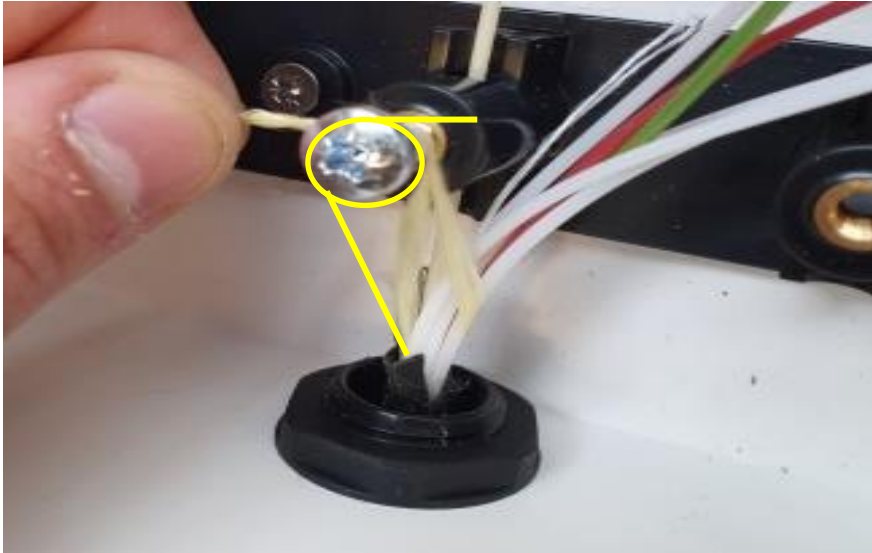

- If the cable contains an aramid strength member, wrap the aramid around the screw thread as many times as possible and tighten screw.

**NOTE: If installing a second cable into an existing entry, you should follow the same steps as above ensuring the original cable retention is not compromised.**

- Fully tighten the nut on the outside of the gland, ensuring any blanks are used at this point for any empty holes in gland seals.

## 4.0 INSTALLING A DROP CABLE

**Step 18**

**Cable Installation complete.**

## 5.0 BOX CLOSEDOWN AND SECURE

### Step 1

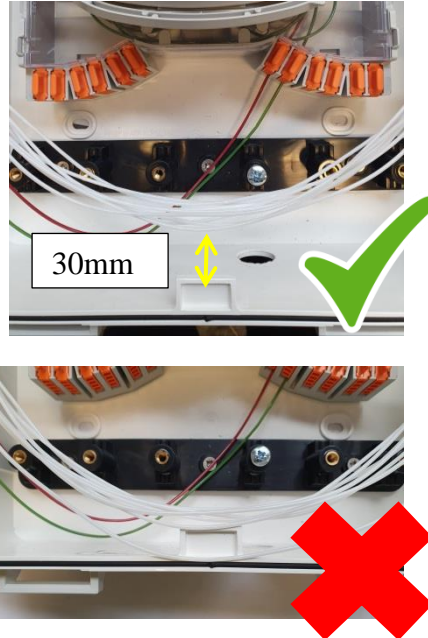

- To close box, first ensure any excess fibre elements are stored appropriately inside the storage catches particularly that the elements do not sit above the tab as indicated.
- Allow a minimum of 30mm distance between stored elements and end of tab.

## 5.0 BOX CLOSEDOWN AND SECURE

### Step 2

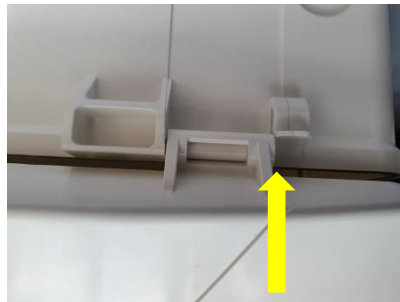
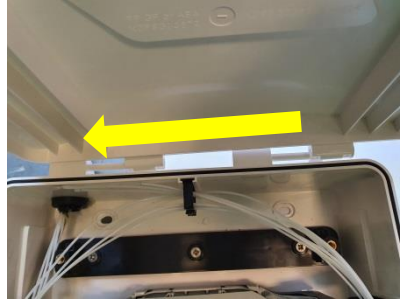

### If Cover was removed

- To add cover, slide horizontally along hinge axis until an audible click is heard.
- Ensure the cover hinge has passed the base tab, as indicated.

## 5.0 BOX CLOSEDOWN AND SECURE

### Step 3



### **If Cover was not removed**

- Snap the cover over the bump on the base and gently bring down to the close position.

**Do not allow the cover to slam shut.**



## 5.0 BOX CLOSEDOWN AND SECURE

### Step 4



- Ensure the two clips are fully engaged at the front.

## 5.0 BOX CLOSEDOWN AND SECURE

### Step 5

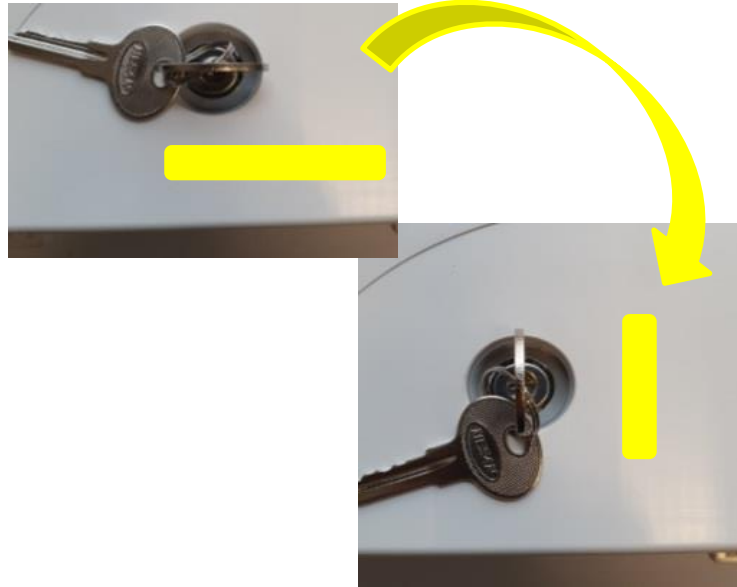

- If using a lock, turn the key at 90° to secure and remove key.

## 5.0 BOX CLOSEDOWN AND SECURE

### Step 6



- If using an external box, ensure all 4 toggles are snapped into the close position. An audible click should be heard.

**Note: failure to do this may result in moisture ingress.**